



1 Door Entry

Recommended:

The clear opening of a doorway should be at least 32" wide. This would require a minimum 2'-10" door.

Code Requirement: State or local codes may apply.

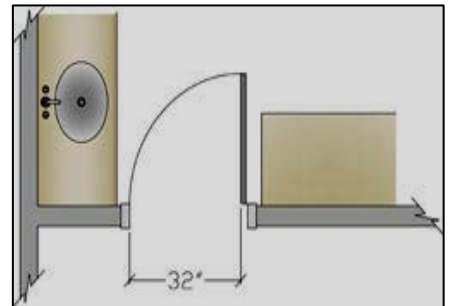

2 Door Interference

Recommended:

No entry door should interfere with the safe operation of appliances, nor should appliance doors interfere with one another.

Code Requirement: State or local codes may apply.

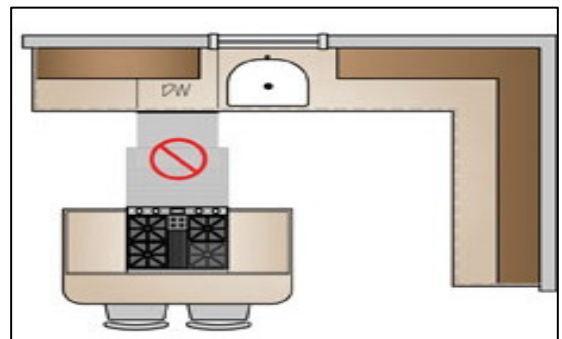
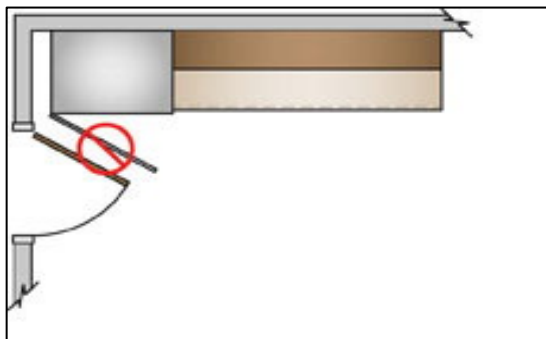

3 Distance Between Work Centres

Recommended:

In a kitchen with three work centers* the sum of the three traveled distances should total no more than 26' with no single leg of the triangle measuring less than 4' nor more than 9'.

When the kitchen plan includes more than three primary appliance/work centers, each additional travel distance to another appliance/work center should measure no less than 4' nor more than 9'.

Each leg is measured from the center-front of the appliance/sink.

No work triangle leg intersects an island/peninsula or other obstacle by more than 12".

*A major appliance and its surrounding landing/work area form a work center. The distances between the three primary work centers (cooking surface, cleanup/prep sink and refrigeration storage) form a work triangle.

Code Requirement: State or local codes may apply.

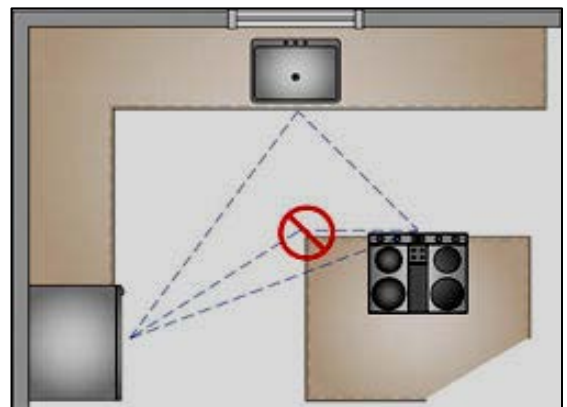
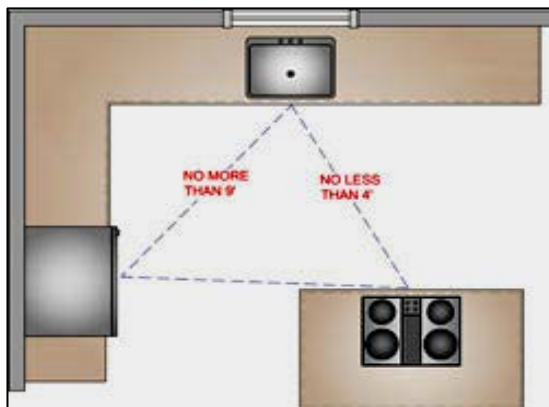

4 Separating Work Centres

Recommended:

A full-height, full-depth, tall obstacle* should not separate two primary work centers.

A properly recessed tall corner unit will not interrupt the workflow and is acceptable.

*Examples of a full-height obstacle are a tall oven cabinet, tall pantry cabinet or refrigerator.

Code Requirement: State or local codes may apply.

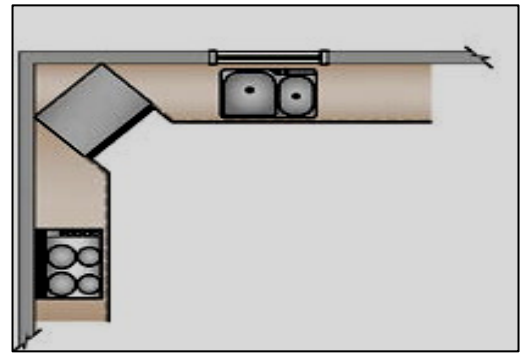
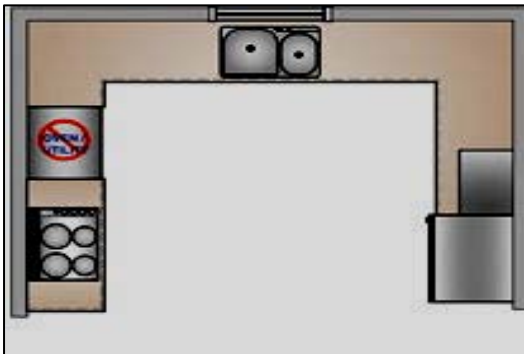

5 Work Triangle Traffic

Recommended:

No major traffic patterns should cross through the basic work triangle.

Code Requirement:

State or local codes may apply.

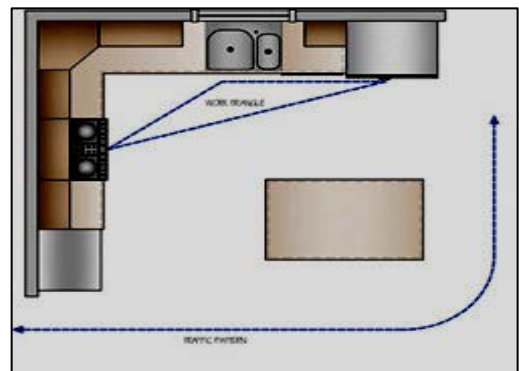

6 Walkway

Recommended:

The width of a walkway should be at least 36".

Code Requirement:

State or local codes may apply.

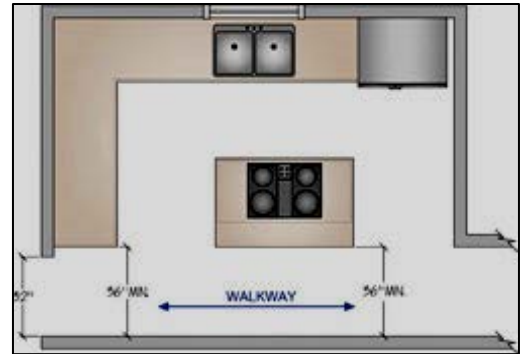

7 Work Aisle

Recommended:

The width of a work aisle should be at least 42" for one cook and at least 48" for multiple cooks. Measure between the counter frontage, tall cabinets and/or appliances.

Code Requirement: State or local codes may apply.

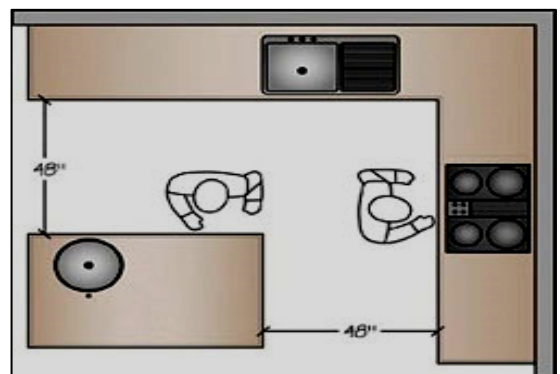
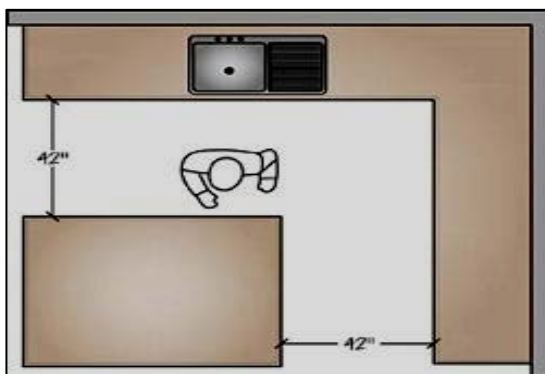

8 Traffic Clearance at Seating

Recommended:

In a seating area where no traffic passes behind a seated diner, allow 32" of clearance from the counter/table edge to any wall or other obstruction behind the seating area.

a. If traffic passes behind the seated diner, allow at least 36" to edge past.

b. If traffic passes behind the seated diner, allow at least 44" to walk past.

Code Requirement: State or local codes may apply.

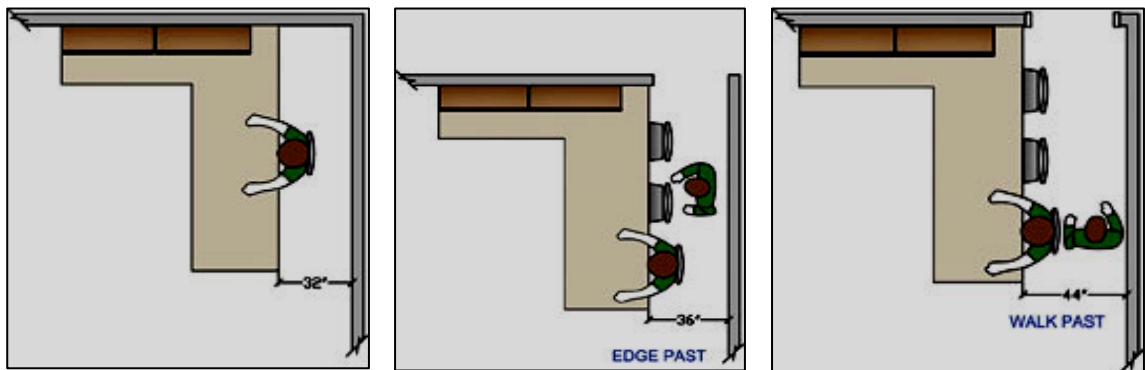

9 Seating Clearance

Recommended:

Kitchen seating areas should incorporate at least the following clearances:

30" high tables/counters: Allow a 24" wide x 18" deep knee space for each seated diner and at least 18" of clear knee space

36" high counters: Allow a 24" wide x 15" deep knee space for each seated diner and at least 15" of clear knee space.

42" high counters: Allow a 24" wide x 12" deep knee space for each seated diner and 12" of clear knee space.

Code Requirement: State or local codes may apply.

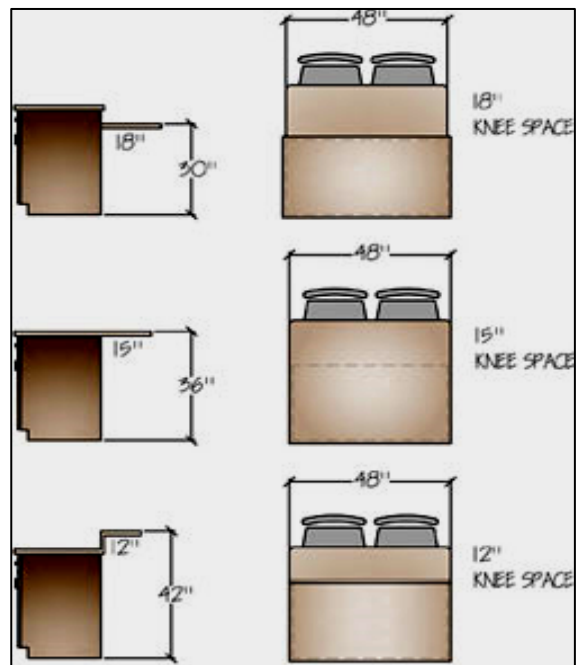

10 Sink Placement

Recommended:

If a kitchen has only one sink, locate it adjacent to or across from the cooking surface and refrigerator.

Code Requirement: State or local codes may apply.

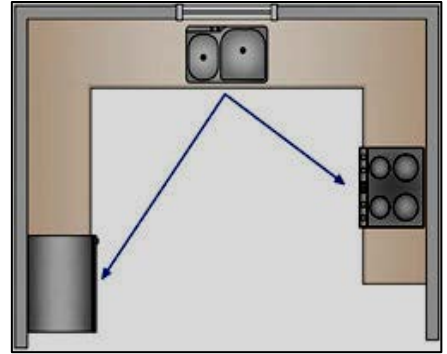

11 Sink Landing Area

Recommended:

Include at least a 24" wide landing area* to one side of the sink and at least an 18" wide landing area on the other side.

If all of the countertop at the sink is not the same height, then plan a 24" landing area on one side of the sink and 3" of countertop frontage on the other side, both at the same height as the sink.

The 24" of recommended landing area can be met by 3" of countertop frontage from the edge of the sink to the inside corner of the countertop if more than 21" of countertop frontage is available on the return.

**Landing area is measured as countertop frontage adjacent to a sink and/or an appliance. The countertop must be at least 16" deep and must be 28" to 45" above the finished floor to qualify.*

Code Requirement: State or local codes may apply.

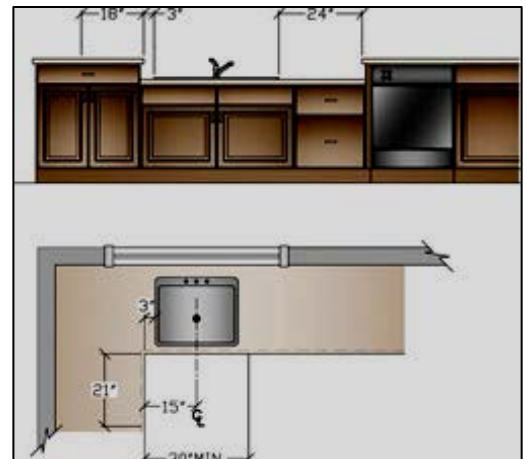

12

Work / Prep Area

Recommended:

Include a section of continuous countertop at least 36" wide x 24" deep immediately next to a sink for a primary preparation/work area.

Code Requirement: State or local codes may apply.

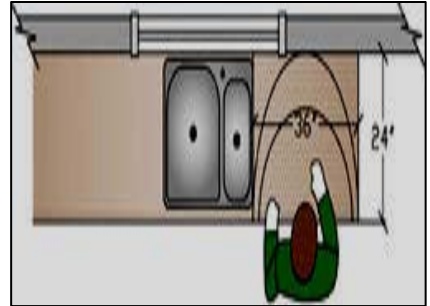

13

Dishwasher Placement

Recommended:

Locate nearest edge of the primary dishwasher within 36" of the nearest edge of a cleanup/prep sink.

Provide at least 21"* of standing space between the edge of the dishwasher and countertop frontage, appliances and/or cabinets, which are placed at a right angle to the dishwasher.

**In a diagonal installation, the 21" is measured from the center of the sink to the edge of the dishwasher door in an open position.*

Code Requirement: State or local codes may apply.

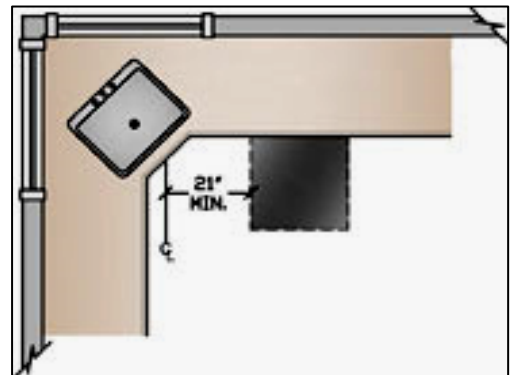
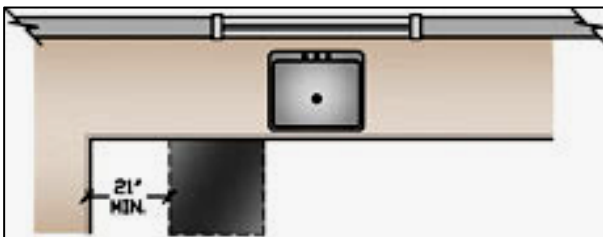
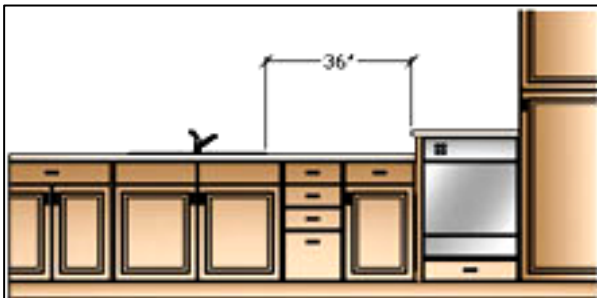

14 Auxiliary Sink

Recommended:

If a kitchen has only one sink, locate it adjacent to or across from the cooking surface and refrigerator.

Code Requirement: State or local codes may apply.



15 Refrigerator Landing Area

Recommended:

Include at least a 24" wide landing area* to one side of the sink and at least an 18" wide landing area on the other side.

If all of the countertop at the sink is not the same height, then plan a 24" landing area on one side of the sink and 3" of countertop frontage on the other side, both at the same height as the sink.

The 24" of recommended landing area can be met by 3" of countertop frontage from the edge of the sink to the inside corner of the countertop if more than 21" of countertop frontage is available on the return.

**Landing area is measured as countertop frontage adjacent to a sink and/or an appliance. The countertop must be at least 16" deep and must be 28" to 45" above the finished floor to qualify.*

Code Requirement: State or local codes may apply.

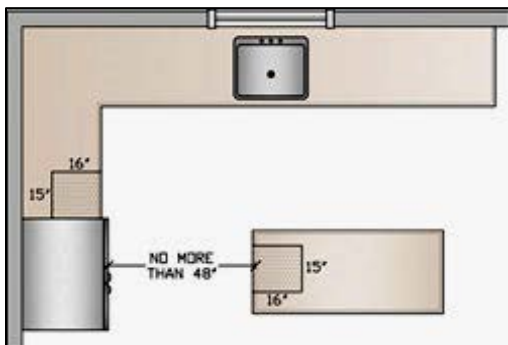

16

Cook Surface Clearance

Recommended:

Allow 24" of clearance between the cooking surface and a protected noncombustible surface above it.

Code Requirement:

At least 30" of clearance is required between the cooking surface and an unprotected/combustible surface above it. (IRC M 1901.1)

If a microwave hood combination is used above the cooking surface, then the manufacturer's specifications should be followed. (IRC M 1504.1)

Refer to manufacturer's specifications or local building codes for other considerations.

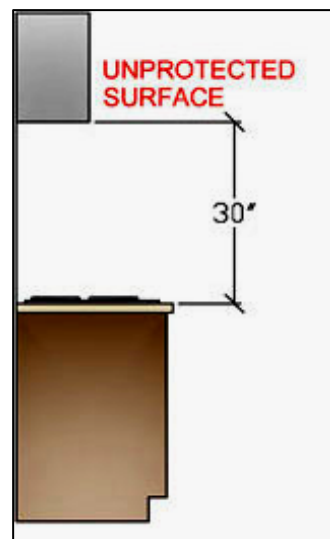
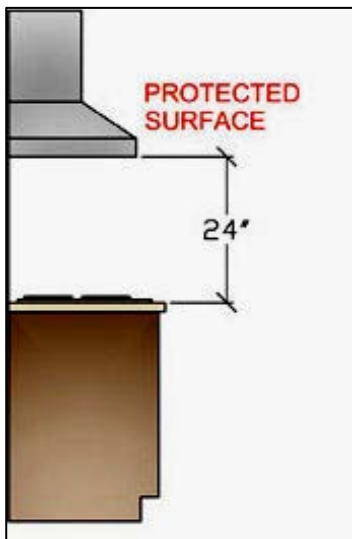

17

Cook Surface Landing Area

Recommended:

Include a minimum of 12" of landing area on one side of a cooking surface and 15" on the other side.

If the cooking surface is at a different countertop height than the rest of the kitchen then the 12" and 15" landing areas must be at the same height as the cooking surface.

For safety reasons, in an island or peninsula situation, the countertop should also extend a minimum of 9" behind the cooking surface if the counter height is the same as the surface-cooking appliance.

For an enclosed configuration, a reduction of clearances shall be in accordance with the appliance manufacturer's instructions or per local codes. (This may not provide adequate landing area.)

Code Requirement: State or local codes may apply.

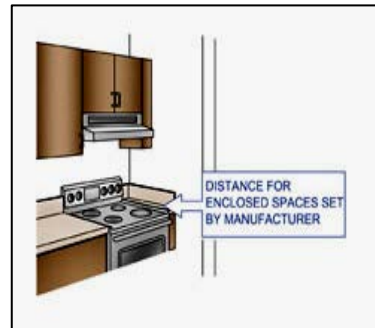
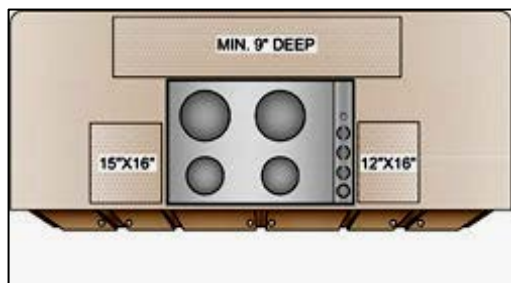
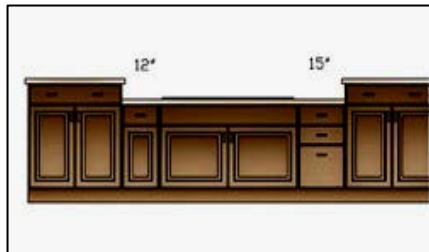

18

Waste Bins

Recommended:

Include at least two waste receptacles. Locate one near each of the cleanup/prep sink(s) and a second for recycling either in the kitchen or nearby.

Code Requirement: State or local codes may apply.

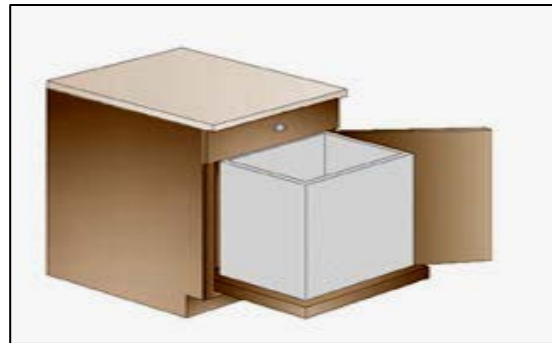
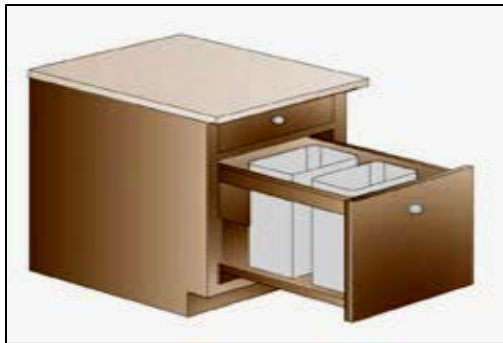

19

Cooking Service Ventilation

Recommended:

Provide a correctly sized, ducted ventilation system for all cooking surface appliances. The recommended minimum is 150 CFM.

Code Requirement:

Manufacturer's specifications must be followed. (IRC G 2407.1, IRC G 2447.1)

The minimum required exhaust rate for a ducted hood is 100 cfm and must be ducted to the outside. (IRC M 1507.3)

Make-up air may need to be provided. Refer to local codes. (IRC G 2407.4)

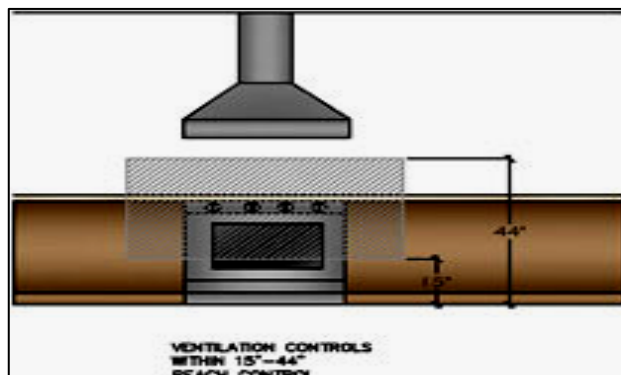

20

Cook Surface Safety

Recommended:

Do not locate the cooking surface under an operable window.

Window treatments above the cooking surface should not use flammable materials.

A fire extinguisher should be located near the exit of the kitchen away from cooking equipment.

Code Requirement: State or local codes may apply.



21

Microwave Oven Placement

Recommended:

Locate the microwave oven after considering the user's height and abilities. The ideal location for the bottom of the microwave is 3" below the principle user's shoulder but no more than 54" above the floor.

If the microwave oven is placed below the countertop the oven bottom must be at least 15" off the finished floor.

Code Requirement: State or local codes may apply.

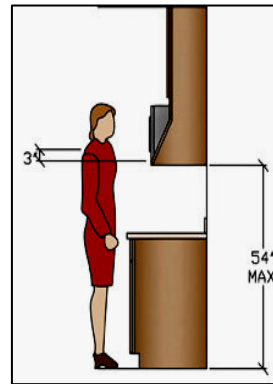
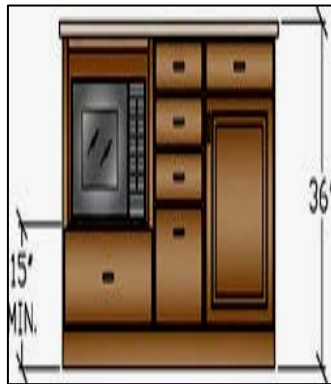

22

Microwave Landing Area

Recommended:

Provide at least a 15" landing area above, below, or adjacent to the handle side of a microwave oven.

Code Requirement: State or local codes may apply.

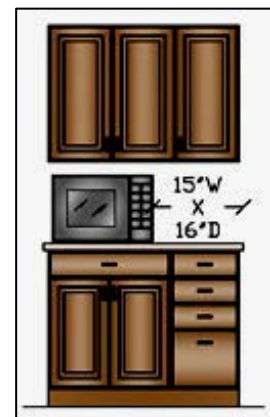
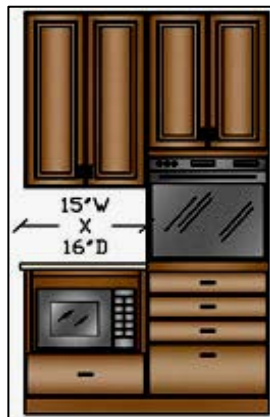
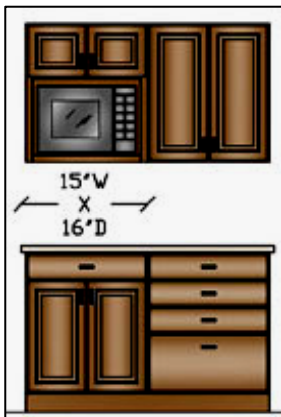

23

Oven Landing Area

Recommended:

Include at least a 15" landing area next to or above the oven.

At least a 15" landing area that is not more than 48" across from the oven is acceptable if the appliance does not open into a walkway.

Code Requirement: State or local codes may apply.

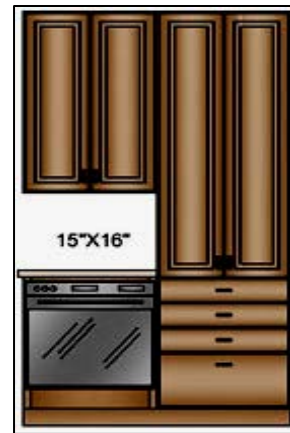
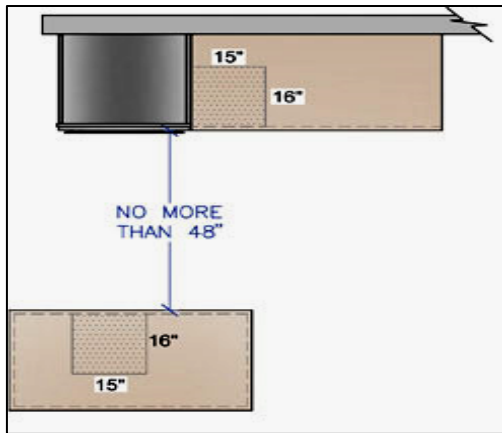

24

Combining Landing Areas

Recommended:

If two landing areas are adjacent to one another, determine a new minimum for the two adjoining spaces by taking the longer of the two landing area requirements and adding 12."

Code Requirement: State or local codes may apply.

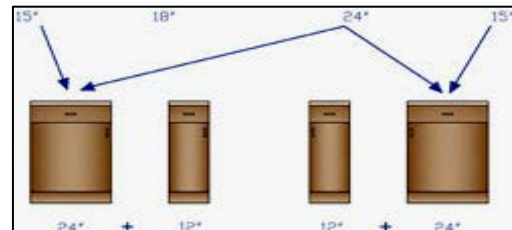
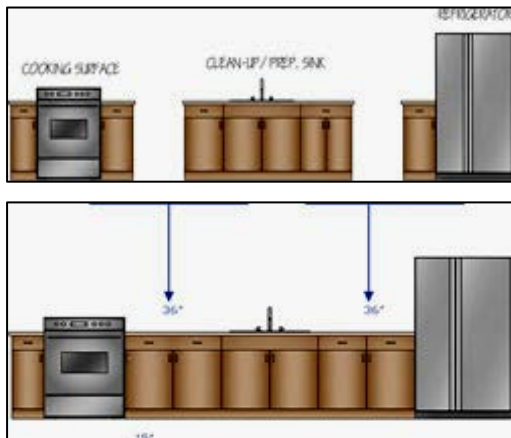

25

Countertop Space

Recommended:

A total of 158" of countertop frontage, 24" deep, with at least 15" of clearance above, is needed to accommodate all uses, including landing area, preparation/work area, and storage.

Built-in appliance garages extending to the countertop can be counted towards the total countertop frontage recommendation, but they may interfere with the landing areas.

Code Requirement: State or local codes may apply.

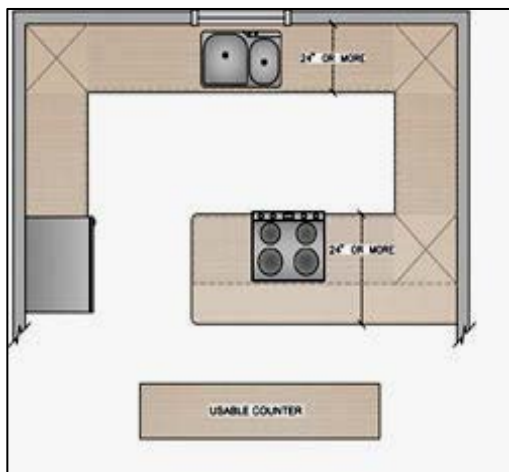

26

Electrical & Lighting

Recommended:

In addition to general lighting required by code, every work surface should be well illuminated by appropriate task lighting.

Code Requirement:

At least one wall-switch controlled light must be provided. Switch must be placed at the entrance. (IRC E 3803.2)

Window/skylight area, equal to at least 8% of the total square footage of the kitchen, or a total living space which includes a kitchen, is required. (IRC R 303.1, IRC R 303.2)

GFCI (Ground-fault circuit-interrupter) protection is required on all receptacles servicing countertop surfaces within the kitchen. (IRC E 3802.6)

Refer to IRC E 3801.4.1 through E 3801.4.5 for receptacle placement and locations.

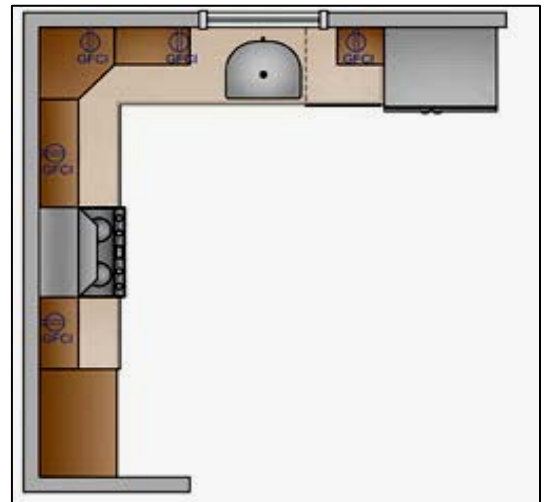
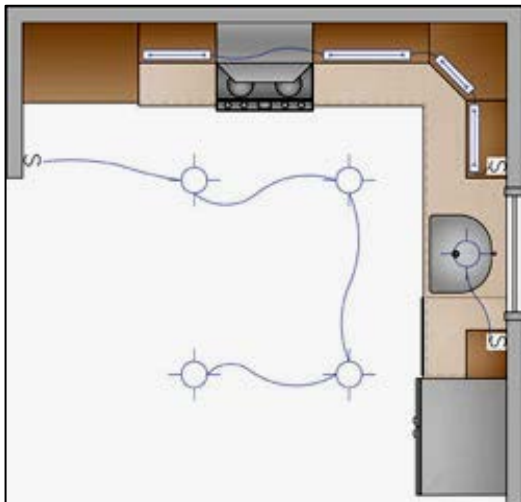

27

Storage

Recommended:

Total shelf/drawer frontage*:
1400" (less than 150 SFT);
1700" (151 to 350 SFT); and
2000" (greater than 350 SFT)

Distribution for the shelf/drawer frontage:

	Small	Medium	Large
Wall	300"	360"	360"
Base	520"	615"	660"
Drawer	360"	400"	525"
Pantry	180"	230"	310"
Misc.	40"	95"	145"

The totals for wall, base, drawer and pantry shelf/ drawer frontage can be adjusted upward or downward as long as the recommended total stays the same. Do not apply more than the recommended amount of storage in the miscellaneous category to meet the total frontage recommendation. Storage areas that are more than 84" above the floor must be counted in the miscellaneous category.

**Shelf and drawer frontage is determined by multiplying the cabinet size by the number and depth of the shelves or drawers in the cabinet, using the following formula:*

Cabinet width in inches x number of shelf/drawers x cabinet depth in feet (or fraction thereof) = Shelf/Drawer Frontage

Code Requirement: State or local codes may apply.

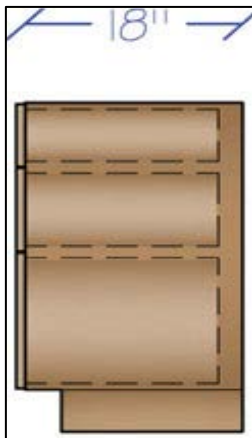

3 drawers 18 x 1 1/2' = 81" drawer storage
Total: 81" drawer storage

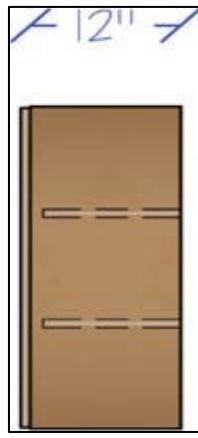

3 shelves 24" x 1' = 72" wall storage
Total: 72" wall storage



1 drawer 24" x 2' = 48" drawer storage
+1 shelf 24" x 1' = 24" base storage
+1 shelf (bottom) 24" x 2' = 48" base storage
Total: 48" drawer storage and 72" base storage

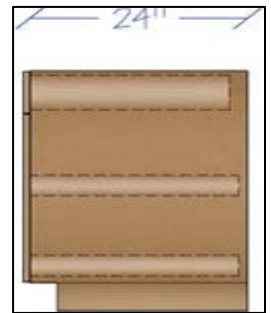

1 drawer 24" x 2' = 48" drawer storage
+2 roll-outs 24" x 2' = 96" drawer storage
Total: 144" drawer storage

28

Sink Storage

Recommended:

Of the total recommended wall, base, drawer and pantry shelf/drawer frontage, the following should be located within 72" of the centerline of the main cleanup/prep sink:

- at least 400" for a small kitchen;
- at least 480" for a medium kitchen;
- at least 560" for a large kitchen.

Code Requirement: State or local codes may apply.

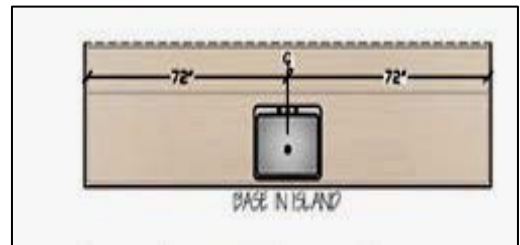
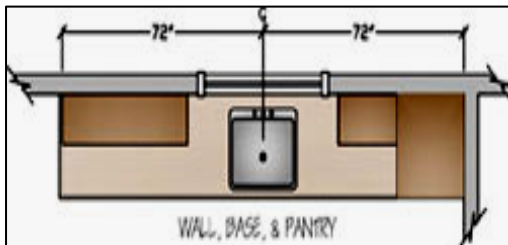

29

Corner Cabinet Storage

Recommended:

At least one corner cabinet should include a functional storage device
This guideline does not apply if there are no corner cabinets.

Code Requirement: State or local codes may apply.

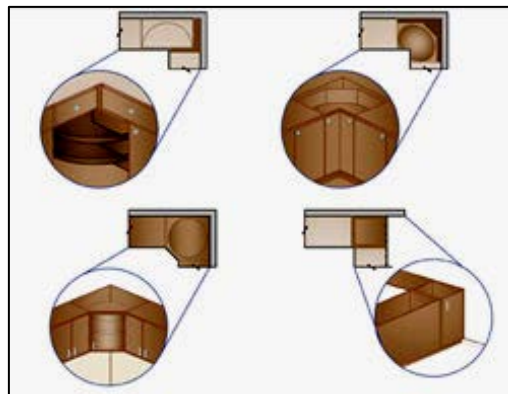

28

Sink Storage

Recommended:

Of the total recommended wall, base, drawer and pantry shelf/drawer frontage, the following should be located within 72" of the centerline of the main cleanup/prep sink:

- at least 400" for a small kitchen;
- at least 480" for a medium kitchen;
- at least 560" for a large kitchen.

Code Requirement: State or local codes may apply.

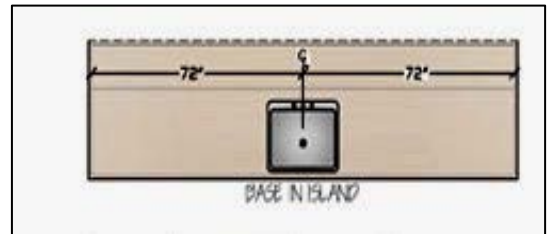
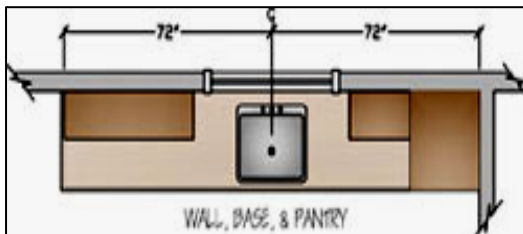

29

Countertop Edges

Recommended:

Specify clipped or round corners rather than sharp edges on all counters.

Code Requirement: State or local codes may apply.

